

SC-632
67312
Anti-Jump
Header Insert

SC-623
67187
1040/740D Header



#5140
Hanger Brkt Screw
for 1040



#4270
Nylon Bushing
for 1040

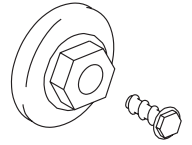

#4357
#4344 HD Roller
Bearing w/Screw

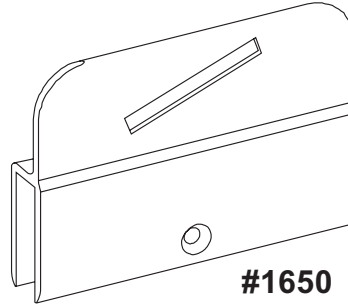

#1650
66445
1040 Hanger Brkt



SC-631
66445
1040 Top Rail

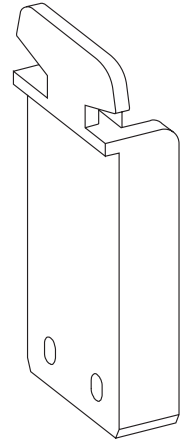

#4339
Header T-Lock
for 740D/1040

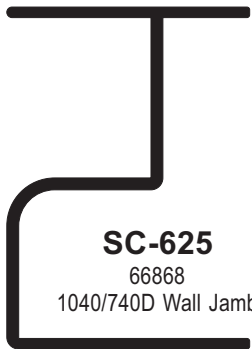

SC-625
66868
1040/740D Wall Jamb

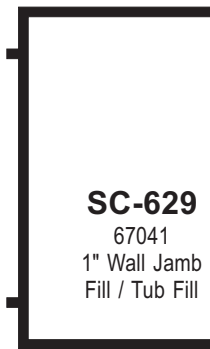

SC-629
67041
1" Wall Jamb
Fill / Tub Fill

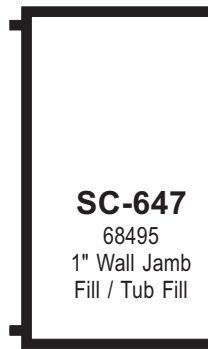

SC-647
68495
1" Wall Jamb
Fill / Tub Fill

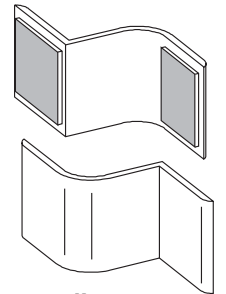

#4346
Wall Jamb Cover
for 740D/1040

V-191
Vinyl Insert for
Frameless Tub Track

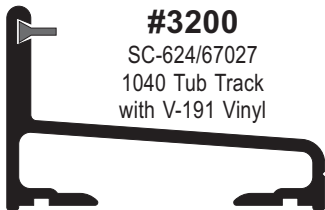

#3200
SC-624/67027
1040 Tub Track
with V-191 Vinyl

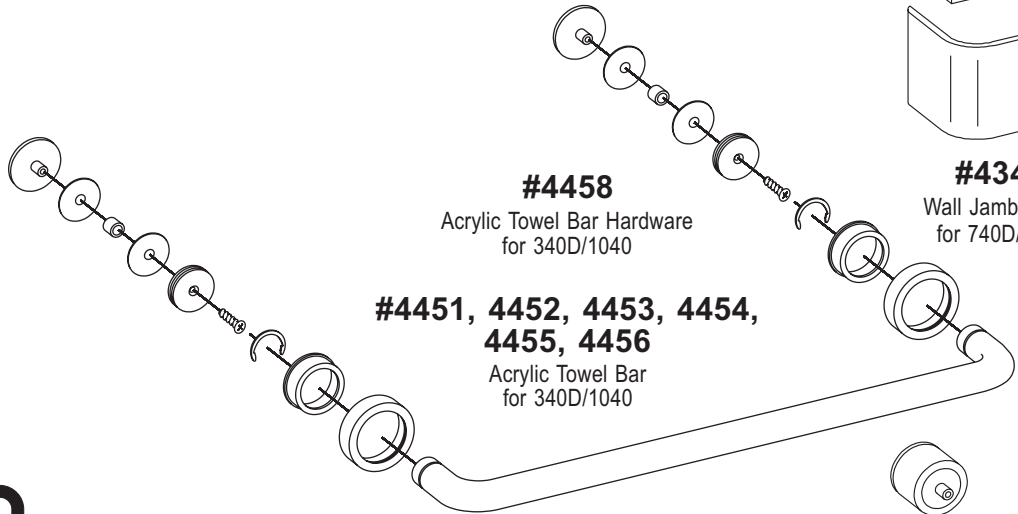

#4458
Acrylic Towel Bar Hardware
for 340D/1040

**#4451, 4452, 4453, 4454,
4455, 4456**
Acrylic Towel Bar
for 340D/1040



#7312
Deluxe Pull
Knob Kit

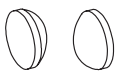

#4297
Clear Vinyl
Jamb Bumpers

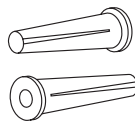

#4106
Plastic Wall Anchors

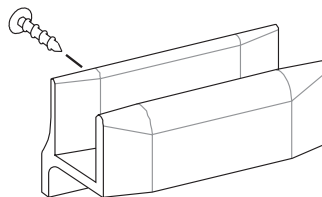

#4373
#4374 Acrylic Panel
Guide with Screw



#4142
Adjustment Wrench

ALUMAX Bath Enclosures
1040/1050 Bypass Enclosure