

**SC-552**  
64520 w/V-293  
Pivot Jamb

**#3387**  
SC-552(64520)/V-338  
Strike Jamb Assy

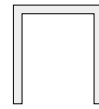

**SC-508**  
63229  
Wall Jamb



**#8442**  
V-296  
1038/1090  
Rail Vinyl

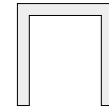

**#8605**  
V-329  
1038/1090  
Rail Vinyl

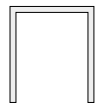

**#8606**  
V-330  
1038/1090  
Rail Vinyl

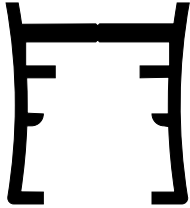

**SC-505**  
63235  
Header



**#4188**  
Long  
Pivot Bushing



**#5080**  
Set Screw for  
Pivot Block

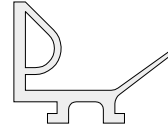

**V-338**  
1090  
Jamb Vinyl



**V-293**  
1038/1090  
Bulb Vinyl

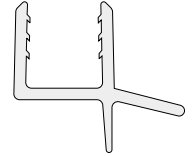

**#8444**  
V-297  
1090 Door Wiper

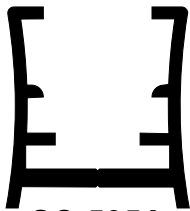

**SC-505A**  
63235  
Curb with  
weep slots



**#4189**  
Short  
Pivot Bushing

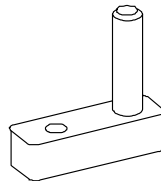

**#4262**  
1038/1090  
Pivot Block

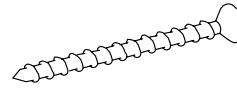

**#5170**  
#8 x 2"  
Screw

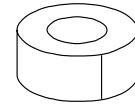

**#4248**  
Double-Stick  
Tape



**SC-610**  
66228  
1090 Curb Fill



**#1080**  
66231  
1090 Header  
& Curb Insert



**#1079**  
66131  
Die used for  
Door Rail

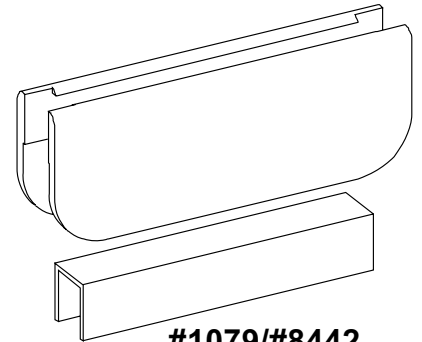

**#1079/#8442**  
1038/1090 Top/Bottom  
Door Rail w/V-296

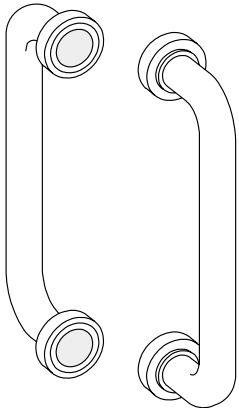

**#18248**  
Acrylic Handle  
Assembly



**#4270**  
Nylon Handle  
Bushing



**#5156**  
Handle  
Attachment  
Screw

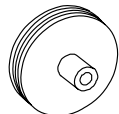

**#4266**  
Handle Disc  
(threaded &  
tapped)

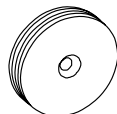

**#4267**  
Handle Disc  
(threaded &  
countersunk)

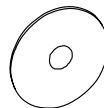

**#4271**  
Handle Washer  
(1 1/8" rubber)

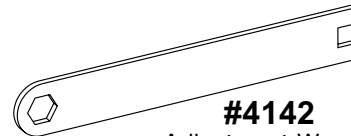

**#4142**  
Adjustment Wrench